



AW1-V

Covert Scouting Camera Instruction Manual



Watch the set-up video on our website at
www.covertscoutingcameras.com



Content

Introduction	3
Camera Overview	5
Button Instructions	6
Purchasing your Plan	7
Activating Multiple Cameras	8
Other Plan Information.....	9
Quick Start	10
Purchasing Your Plan	11
Connecting your Camera to Cloud Server	11
Settings and Start	12
The Light Information	14
Manual Photo	15
Customizing the camera settings.....	16
Mounting	Error! Bookmark not defined.
Warranty.....	19
Technical Specifications	28

Introduction

The camera has these characteristics: small size, only two buttons, and no screen. So the camera's settings are all controlled by a cloud platform, but it can also shoot pictures manually.

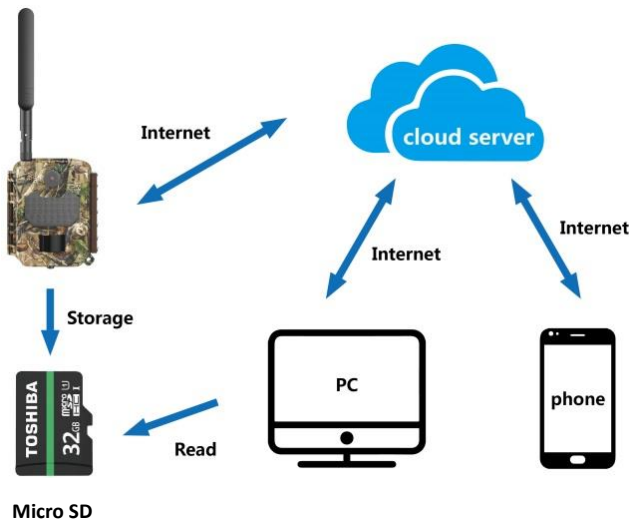

What you will need to set this camera up:

-Internet Access to Choose Your Plan.

<https://secure.covert-wireless.com>

-8 AA Batteries

-Micro SD Card (Up to 32G)

-Nano SIM Card (Included)

Camera Overview

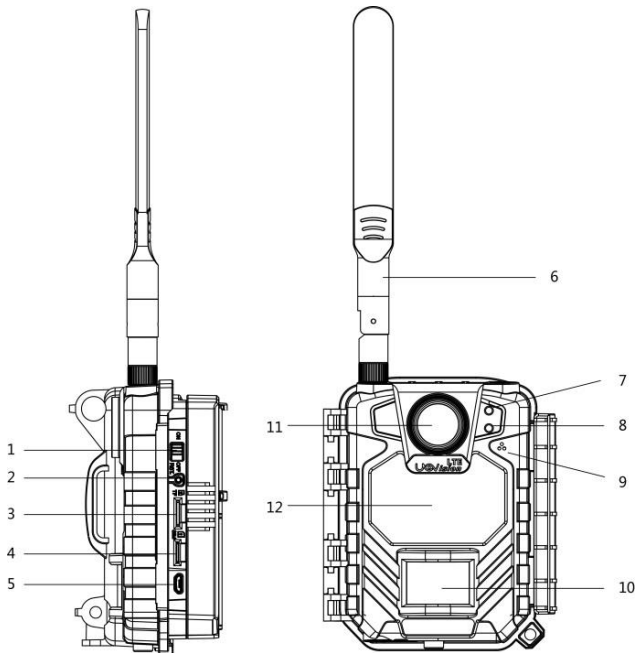

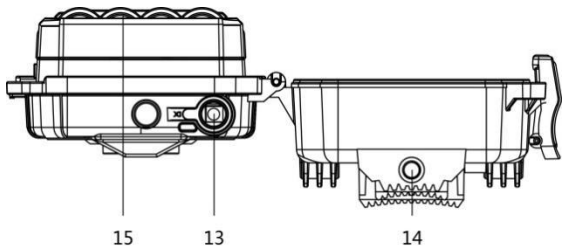

1. Switch
2. Reset
3. Micro SD slot
4. Nano SIM slot
5. USB
6. Antenna
7. "PIR & Power" Light
8. "Status" Light
9. MIC
10. PIR
11. Lens
12. IR Flash LED

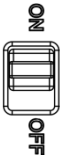

13. 6V Jack 14. Tripod stand 15. Eject button

Button Instructions

Button	Function description
 <p>ON</p> <p>OFF</p>	<p>ON: Working mode; OFF: Power off (Please remove batteries when not in use);</p>

 The logo for RST (Remote Security Tool) features the letters 'RST' in a bold, sans-serif font, oriented vertically. Below the text is a stylized graphic of a camera lens or sensor, consisting of several concentric circles and lines that suggest depth and focus.	<p>①: Press the button and the camera will take a manual photo and automatically send to the app.</p> <p>②: Hold it and push the switch to ON, if there is a FW installed on the Micro SD Card, the camera will update.</p>
---	---

Sounds information:

Beeps once: upgrade is completed.

Beeps twice: no SIM card.

Beeps thrice: no SD card.

Purchasing your Plan

Follow these simple steps to activate or renew a **Verizon** plan:

1. Open your web browser to: <https://secure.covert-wireless.com>
2. Select the type of plan you'd like to add.
3. Follow the prompts to select your **rate plan**, enter your **personal/billing information** and complete your purchase.
4. Log back into your account.

5. Enter the ICCID number located on the SIM card included with your camera. Then enter the IMEI for your camera found on the inside white label of the camera or on the outer packaging.



6. Click the green activate button and refresh your page.
7. Rename your camera in the nickname field provided.
(OPTIONAL)

Activating Multiple Cameras

Same Rate Plan- To activate multiple cameras on the same rate plan, simply enter the ICCID and IMEI number under said rate plan and click activate.

Note: You can activate as many cameras as you'd like on a rate plan. Rate plans are charged on device quantities.

Different Rate Plan- To activate cameras on a different rate plan, scroll to **Purchase Additional Subscription Plans**. Select the provider and the rate plan of your choice. This will add the rate plan option under **My Services and Equipment**.

Other Plan Information

Auto Renew: Covert Wireless plans automatically renew, however there is no long-term contract. To opt out of your billing for certain months, simply hover over the “ACTIVE” button and click. You will no longer be billed for services until you log back into your account and “click to activate.”



Quick Start

Before you start, you need to prepare a Micro SD Card (up to 32G), a Nano SIM card and 8 AA batteries. Please insert them correctly.

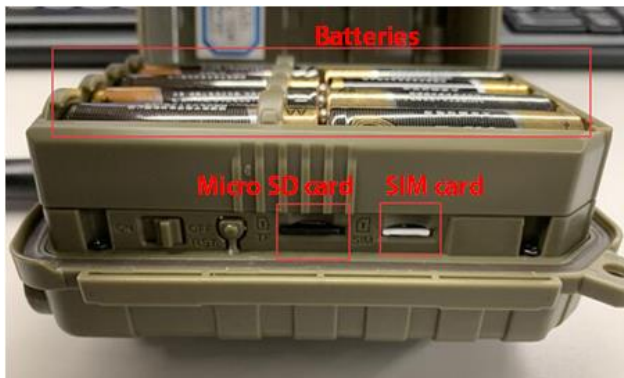

Connecting your Camera to the Cloud Server

Login to your cloud account at:

www.covert-wireless.com.

This is the same login that you used to set up your account at:

www.secure.covert-wireless.com.



Have you signed up for a data plan yet?

Yes, Log In

OR

Login as guest

OR

No, Sign Up Now

a. Open: <https://www.covert-wireless.com/>

b. If you already have an account, just login. If not, register one with your email address at: www.secure.covert-wireless.com

Settings and Start

You can change the camera settings via APP. Click 'Save' to save and send the settings. Slide the power switch to 'ON', the camera will receive settings and start to work.

Mode	<input type="radio"/> Picture <input checked="" type="radio"/> Video
Video Size	<input checked="" type="radio"/> WVGA <input type="radio"/> 720P <input type="radio"/> 1080P
Video Length	<input type="text" value="20"/> <input type="button" value="v"/>
Trigger Mode	<input type="radio"/> PIR <input type="radio"/> Time Lapse <input checked="" type="radio"/> Both
Sensitivity	<input type="radio"/> Low <input checked="" type="radio"/> Normal <input type="radio"/> High
Trigger Interval	<input type="text" value="30"/> <input type="button" value="v"/>
Trigger Interval Unit	<input checked="" type="radio"/> Seconds <input type="radio"/> Minutes
Time Lapse Interval	<input type="text" value="10"/> <input type="button" value="v"/>
Time Lapse Unit	<input type="radio"/> Seconds <input checked="" type="radio"/> Minutes <input type="radio"/> Hours
Work Time 1	<input type="checkbox"/> OFF
Work Time 2	<input type="checkbox"/> OFF
Work Time 3	<input type="checkbox"/> OFF
Work Time 4	<input type="checkbox"/> OFF
Overwrite	<input checked="" type="checkbox"/> ON
Use Timestamp	<input checked="" type="checkbox"/> ON
Flashpower	<input type="radio"/> Low <input checked="" type="radio"/> High
Remote Control	<input type="text" value="RealTime"/> <input type="button" value="v"/>
<input checked="" type="button" value="Save"/>	

The Light Information

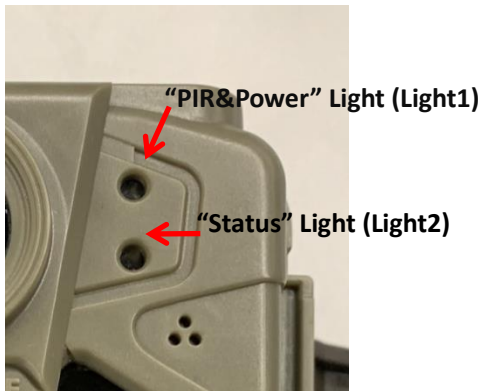

	Color	Slow flash	Steady	Fast flash
Light1	Red	PIR is working		Low power
Light2	Green	Searching for signal	Good signal	Sending pictures
	Yellow-green		Weak signal	
	Red		No signal	

* The camera begins to monitor when the two lights off.

Manual Photo

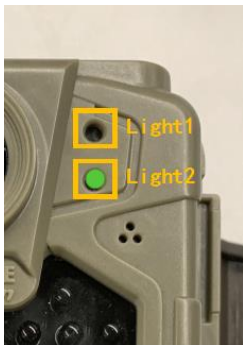

You can manually take a picture and check if your APP has successfully received the photo.

Press the “RST” button when the light 2 is green or yellow-green. Camera will shoot a picture at once and send to cloud platform.

The cloud platform will receive the photo within 30 seconds if the camera has a good signal.

If light 2 become red after manually shooting, it means the picture did not send. We suggest checking this:

- Micro SD Card's capacity (Up to 32G)
- That you have an active plan with Verizon.

Customizing the Camera Settings

Instant: Enables instant transmission. Max Number of “Instant” means the number of photos that is allowed to send out per day. If you want to control your data flow, set the maximum number. The number 00 means unlimited.

Remote Control: You can remotely control your camera via mobile phone or web-portal. If you choose Real Time, the wireless module will keep working so the power consumption is huge. Delay 24H means the wireless module will wake up at least one time in 24 hours but will continue to send pictures when triggered by heat or motion.

Mode: You can choose **Photo Mode** or Video Mode. Choosing Photo Mode, you can change Photo Size, set Flash power, and **Photo Burst** in Photo Mode. Choosing **Video Mode**, you can further set the Video Size and Video Length.

Photo Burst: Your camera can take a 1-10 shot burst every time the PIR is triggered to take a photo.

Sensitivity: There may be situations where you might feel the camera is not catching animals too easily. You can adjust the sensitivity of your camera to help with this. Under most conditions, the Normal option will work the best. In high temperatures, the High setting might help differentiate between the outside temps and the body temps of the animal. In cold conditions, you may find that the Low option is best as the camera can easily differentiate the outside temps from the body temps of the subject.

Trigger Interval: Allows you to customize how often the camera can be allowed to take a photo.

Time Lapse: This option allows your camera to automatically take a photo without being triggered by the PIR.

Work Time: The camera can work at preset times and preset days. In the rest of the time the camera is not work. Work hour: 00:00-00:00 means 24 hours. If the settings is cross the day, for example: Start: 20:00 Stop: 10:00 means 00:00-10:00 am and 20:00-24:00 of the chosen day.

Overwrite: The overwrite function will save new photos over the old photos on your Micro SD Card if it becomes full. Each time a new photo is taken the oldest photo on the card will be overwritten.

AUXILIARY POWER: Your camera comes with a standard 4mm Auxiliary power jack. If you want to hook up an external 6V battery to power the camera, you can. The jack necessary to make the connection is a standard 4mm jack.

Tricks and Tips on Field Setup:

- For best results, mount the camera approximately 3 feet off the ground facing straight forward, as level as possible.
- To enhance the flash, we recommend positioning the camera in an area with a backdrop to reflect the maximum amount of light. For instance, place the camera 20-30' from a field edge facing the woods. For the

inside of timber, positioning the camera facing a thicket approximately 20-30' away.

- Try to set the camera up so it's not facing directly into the sun either in the morning or the evening when game movement is at its peak.
- Use the Covert Tree60 mounting system to mount the camera up higher pointing down on them for a better look. Works great when you don't have a straight tree to attach to.
- The FW version is reference to our engineers to ensure a speedy and efficient warranty repair should the need arise.

Covert Scouting Cameras Warranty:

Covert Scouting Cameras warranties this product for a period of two (2) years from the date of purchase.

This warranty only covers manufacturer's defects and does not cover damage caused by misuse or abuse of the product. This warranty includes two years repair

or replacement service on product from date of purchase. If you have problems with this product, please do not contact the store you purchased it from. Contact Covert Scouting Cameras Customer Service toll free at 877-462-1799 or e-mail support@dlccovert.com.

**** Proof of purchase required for replacement****

Covert Warranty Policy and Procedure:

To receive repair or replacement by Covert Scouting Cameras two-year warranty, we ask you to do the following:

-All returns must have a Return Authorization (RA#) prior to sending in the camera.

1. E-mail or call our customer service department.

-support@dlccovert.com

-toll free: 877-462-1799

Please explain to the technician what issues you are having with your camera.

2. If you are asked to return your camera to Covert Scouting Cameras, you will be

responsible for the cost of shipping to Covert Scouting Cameras. In return, Covert will provide fast and exceptional service as well as incur the cost of shipping back to you. (Only within the Continental United States.)

3. Please include the following information when sending in your camera.
 - RA# on outside of package
 - Return address
 - Telephone and Email address
 - Brief description of the problem
 - Copy of proof of purchase
4. Please make sure all the accessories are removed (i.e. SD Cards, batteries, solar panels SIM cards, straps, ETC.) before shipping. All accessories received by Covert Scouting Cameras will NOT be returned.
5. This warranty only covers manufacturer's defects and does not cover damaged caused by misuse or abuse of the product.

Covert International Warranty Policy and Procedure:

1. Outside the US, service is the available through the distributor/reseller of purchase.
2. All returns must have an RA# provided by Covert. Copy of Proof of Purchase is required for all returns.
3. Covert is not responsible for lost or damaged products incurred during the shipping process.
4. Insurance for returns is at the discretion of the customer. Additional charges apply for return shipping. In the maintenance of the product, Covert Scouting Cameras may use new or like-new assemblies or products for equal or improved quality. All defective parts, assemblies, and products become the property of Covert. Returns and claims will be handled according to the current Covert Scouting Cameras, Inc. procedure.

These warranties shall not apply to any defect, failure or damage caused by improper use or inadequate maintenance and care. Covert shall not be obligated under these warranties to repair:

- a. Damage resulting from attempts by personnel other than Covert representatives to install, repair or service the product unless directed by a Covert representative.
- b. Damage, malfunction or degradation of performance resulting from improper use or connection to incompatible equipment or memory.
- c. Damage, malfunction, or degradation of performance caused by the use of non-Covert supplies or consumables or the use of Covert supplies not specified for use with this product.
- d. An item that has been modified or integrated with other products when the

effect of such modification or integration increases the time or difficulty of servicing the product or degrades performance or reliability.

- e. To perform user maintenance or cleaning or to repair damage, malfunction.
- f. Damage, malfunction or degradation of performance resulting from use of the product in an environment not meeting the operating specifications set forth in the user manual.
- g. Damage, malfunction or degradation of performance resulting from failure to properly prepare and transport the product as prescribed in published product materials.
- h. Any failure to register the product warranty within 10 days of purchase.

- i. To replace items that have been refilled, are used up, abused, misused, or tampered with in any way.
- j. To install replacement items that are not considered customer replaceable.
- k. To support software not supplied by Covert
- l. To provide software or firmware updates or upgrades.

Any service identified in the above list and provided by Covert at the Customer's request shall be invoiced to the customer, at Covert's then current rates for parts, labor and shipping.

THE ABOVE WARRANTIES ARE GIVEN BY COVERT WITH RESPECT TO THIS PRODUCT AND ITS RELATED ITEMS IN LIEU OF ANY OTHER WARRANTIES, EXPRESS OR IMPLIED. COVERT AND ITS VENDORS DISCLAIM ANY IMPLIED WARRANTIES OF MERCHANTABILITY OR FITNESS FOR A PARTICULAR PURPOSE OR ANY SIMILAR STANDARD IMPOSED BY APPLICABLE LEGISLATION. COVERT'S REponsibility TO REPAIR OR REPLACE, FOR

DEFECTIVE PRODUCTS AND RELATED ITEMS IS SOLE AND EXCLUSIVE REMEDY PROVIDED TO THE CUSTOMER FOR BREACH OF THESE WARRANTIES.

Some states, provinces, and countries do not allow the exclusion or limitation of incidental or consequential damages or exclusions or limitation on the duration of implied warranties or conditions, so the above limitations or exclusions may not apply to you. This warranty gives you specific legal rights, and you may have other rights that vary by state, province, or country.

TO THE EXTENT ALLOWED BY LOCAL LAW, EXCEPT FOR THE OBLIGATIONS SPECIFICALLY SET FORTH IN THIS WARRANTY STATEMENT, IN NO EVENT SHALL COVERT AND ITS VENDORS BE LIABLE FOR ANY INDIRECT, SPECIAL, INCIDENTAL OR CONSEQUENTIAL DAMAGES (INCLUDING LOSS OF PROFITS) WHETHER BASED ON CONTRACT, TORT, OR ANY OTHER LEGAL THEORY AND IRRESPECTIVE OF WHETHER COVERT OR THE VENDOR

HAS ADVANCE NOTICE OF THE POSSIBILITY OF SUCH DAMAGES.

Technical Specifications

Image Quality	3/5/8/12/16/20MP
Lens	F/NO=1.85 FOV (Field of View)=64°
PIR Detection Range (meter)	80 feet
PIR angle	54°
Video Quality	WVGA/720P/1080P with Audio
Trigger Time	0.4s
Trigger Interval	5s-60min
Time Lapse	3min-24hours
Work Time	Up to Four operation settings
Photo Burst	1-10
SD Overwrite	Supported
Flash range	100 foot
Infrared LED's	40pcs 940nm LEDs
Camera color	Camo
Network	LTE, real 4G network.
Frequency Bands	AT&T: FDD-LTE B2/B4/B12; UMTS/HSDPA/HSPA+ B2/B5; Verizon: FDD-LTE B4/B13;
Wireless function	Free cloud platform with remote control features; Free Web-portal and APP (Android & IOS); Send VGA pictures to cloud platform. Support retrieving high quality pictures or 5s WVGA video clips.
GPS	Support
Power	8*AA rechargeable batteries(Not included);Supports 6V external power
Other Interface	Micro SD Card(Up to 32GB), Nano-SIM,
Operation/Storage Tem	-68°F - +140°F / -77°F -+140°F
Operation Humidity	5% - 90%

Waterproof Grade	IP66
Mounting	Belt/Cable Lock/Threaded/Adjustable angle bracket
Dimensions	5" x 4.25" x 2.5"
Weight	.63 lbs without batteries)