

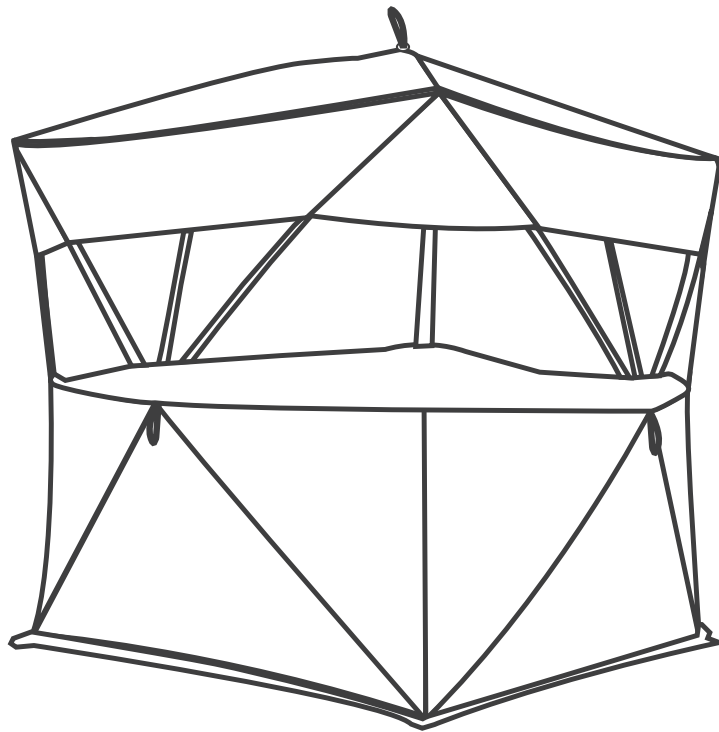

# INSTRUCTIONS & SAFETY GUIDE



## 5 HUB-STYLE GROUND BLIND



READ AND UNDERSTAND ALL INSTRUCTIONS and WARNINGS FIRST.  
Follow these instructions to prevent damage and injury. If you have any  
questions regarding the use of this product contact us.



---

Outdoor Product Innovations, INC.  
177 Reaser Court, Elyria, OH 44035  
888-507-2021  
[www.RHINOBLINDS.com](http://www.RHINOBLINDS.com)



**DON'T FORGET**  
IN ORDER TO ACTIVATE YOUR WARRANTY  
YOU MUST REGISTER YOUR BLIND AT  
[www.rhinoblinds.com/warranty](http://www.rhinoblinds.com/warranty)

## **Rhino Blinds "The Toughest Ground Blind Known To Man"**

Thank you for your purchase; to prevent damage and injury please take a moment to read and review these important safety tips and warnings.

### **SAFETY TIPS**

- DO NOT USE A HEATER IN YOUR BLIND AS UN-VENTED FUMES COULD CAUSE SICKNESS OR DEATH
- THIS PRODUCT IS NOT FIREPROOF. NEVER EXPOSE YOUR BLIND TO ANY OPEN FLAME.
- DO NOT SHOOT THROUGH MESH WITH A FIREARM SPARK OR FLAME FROM THE MUZZLE COULD IGNITE THE MATERIAL
- DO NOT SHOOT EXPANDABLE BROADHEADS THROUGH SHOOT-THROUGH MESH WINDOWS - THE MESH MAY CAUSE PREMATURE OPENING OF THE BLADES. USE FIXED BLADE BROADHEADS ONLY
- FOR BEST ARROW FLIGHT THROUGH SHOOT-THROUGH MESH WINDOWS, ALIGN THE BLADES OF THE BROADHEAD WITH FLETCHING
- DO NOT ALLOW CHILDREN TO PLAY WITH THIS PRODUCT WITHOUT ADULT SUPERVISION
- DO NOT ALLOW MATERIAL TO COVER YOUR FACE. IT CAN CAUSE SUFFOCATION AND DEATH
- DO NOT ALLOW ANYONE TO USE LIGHTED CANDLES, MATCHES OR OTHER SOURCES OF FIRE NEAR THIS PRODUCT.

### **STORAGE & TIPS**

- Store blind in a cool dry place - free of dirt and any debris including native brush
- Never pack and store blind wet or damp
- To stop any leakage, use seam sealer on all seams and silicone spray on seams/sidewalls.
- Avoid leaving your blind outdoors for any extended period of time. Prolonged exposure to sunlight may cause fabric to fade.

### **WARNING: KEEP ALL FLAME AND HEAT SOURCES AWAY FROM TENT FABRIC**

The fabric will burn if left in continuous contact with a flame source. The application of any foreign substance to the tent fabric may render the flame resistant properties ineffective. This tent is made of flame-resistant fabric. It is not fireproof. Do not use candles, matches or open flames of any kind in or near a tent; do not cook inside a tent; do not smoke in a tent; do not store flammable liquids inside a tent; build campfires downwind and several meters away from a tent and be sure to fully extinguish campfires before leaving a campsite or before retiring for the night; exercise extreme caution when using fuel-powered lanterns or heaters inside a tent and use battery operated lanterns whenever possible; do not refuel lamps, heaters or stoves inside a tent; extinguish or turn off all lanterns before going to sleep.

### **UV (ULTRA VIOLET LIGHT) WARNING:**

Ultraviolet light breaks down lightweight fabric fibers (and almost any synthetic material). The material will fade (discolor), lose strength and eventually disintegrate if left in prolonged sunlight. To extend the life of your Rhino Blind avoid leaving it out in direct sunlight. Set up your portable ground blind or accessory in a shady spot whenever possible to extend the product life.

Be sure to follow these guidelines for using your product.

**READ AND UNDERSTAND ALL INSTRUCTIONS AND WARNINGS FIRST.**

If you have any questions about the use of this product contact us.

---

**Outdoor Product Innovations, INC.**  
**177 Reaser Court, Elyria, OH 44035**  
**888-507-2021**  
**[www.RHINOBLINDS.com](http://www.RHINOBLINDS.com)**



# SET-UP



1. Remove your Rhino Blind out of the bag and face the hubs toward you.

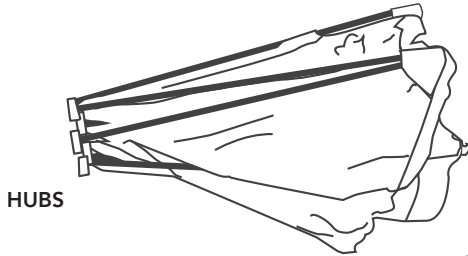

FIG 1

2. Select 2 rods from the same hub and fold them back to form a square. (Fig 2)

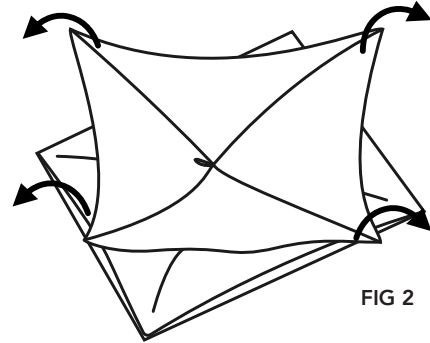

FIG 2

3. "Pop" out the panel by pulling on the strap. (Fig 3) **Note: You can start with any hub but starting with a wall is recommended**

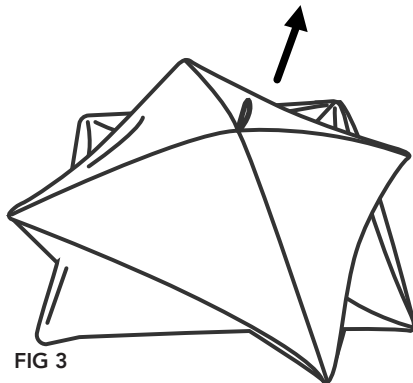

FIG 3

4. Lift the blind until you can access the roof hub and pull the strap to "pop" the roof panel. (Fig 4)

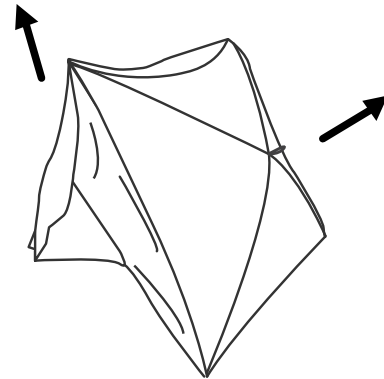

FIG 4

5. Move around your blind, pulling the hubs one at a time, until all hubs are popped out. (Fig 5)

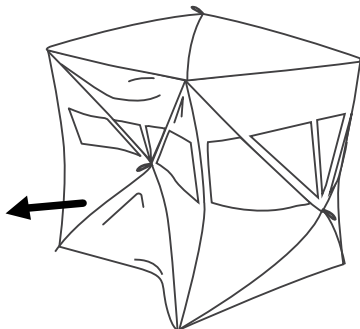

FIG 5

6. Your Rhino Blind should now be set . (FIG 6). Take the included tent stakes and tie-downs and secure to the ground. Adjust window openings, and add native brush to brush-in straps (If available on your model) to optimize your camouflage.

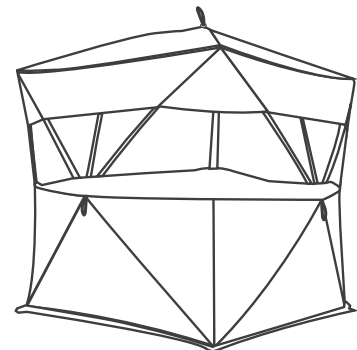

FIG 6



# TAKE-DOWN



**1.** Exit blind, close all windows and door, remove all stakes and tie downs and store them in the included pouch.

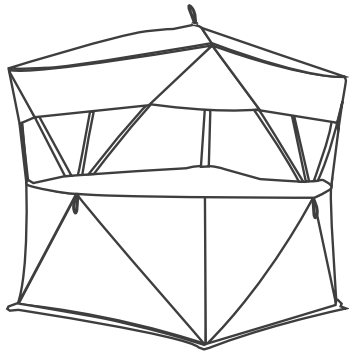

**2.** Carefully push down the center hub of the roof until the tension begins to release. FIG 7

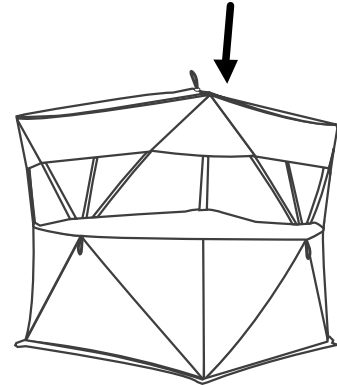

FIG 7

**3.** With an open palm carefully push the center hub of any of the walls until the tension begins to release. (FIG 8) After 3 wall panels are collapsed, allow the blind to fall in on top of itself. (FIG 9)

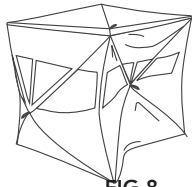

FIG 8

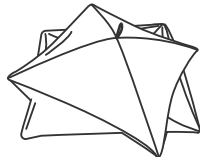

FIG 9

**4.** Collapse the remaining wall by pushing down on the hub from the top. (FIG 10)

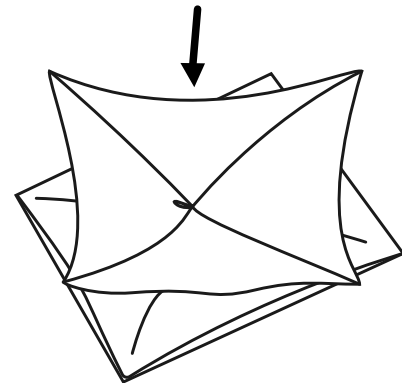
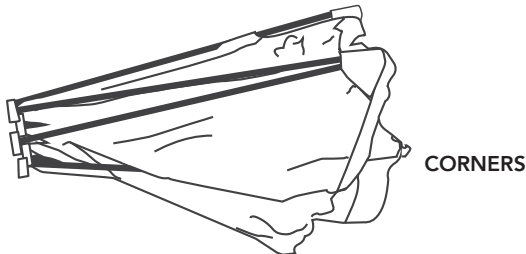

FIG 10

**5.** Gather the corners of the blind and fold the blind up (FIG 11)

FIG 11



**6.** Rotate and roll the blind to fit it into the included back pack bag.

NOTE: Images used are for instruction purposes only. The images not depict final product.